

MAPS™ 5G N8 Interface Emulator

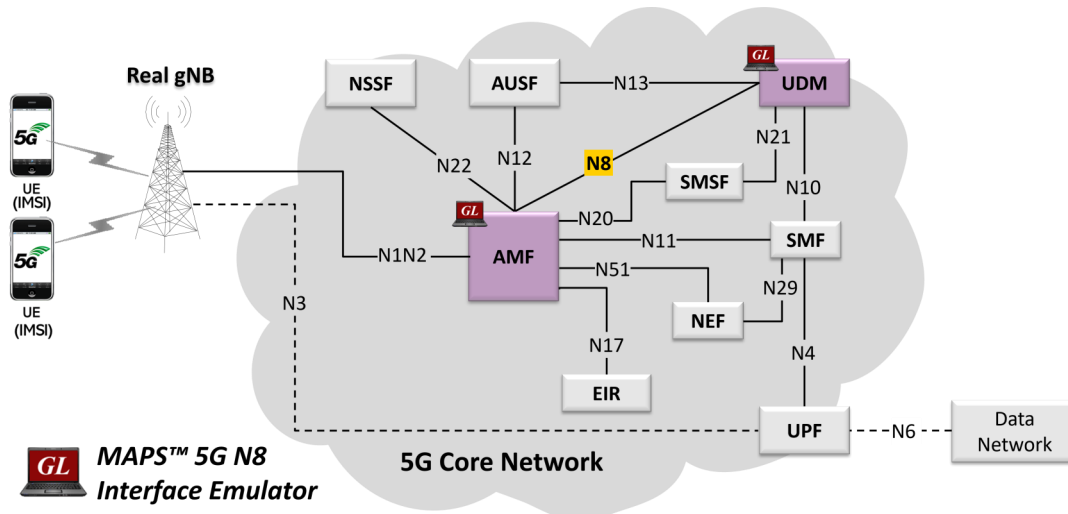

Overview

5G System as a service-based Architecture, includes a set of Network Functions (NFs) providing services as defined in 3GPP TS 23.501. The service-based interfaces use HTTP/2 protocol with JavaScript Object Notation (JSON) as the application layer serialization protocol. GL's MAPS™ emulates Unified Data Management (UDM) within the 5G Core offering services to the Access and Mobility Management Function (AMF) via the Nudm service-based N8 interface. The figure represents the service based interface, with focus on the UDM and AMF.

The NF, UDM is the entity in the 5G Core Network (5GC), which supports Nudm_SubscriberDataManagement, Nudm_UEContextManagement, Namf_MT, Namf_Location and Namf_Communication services via the Nudm and Namf service-based N8 interface. Here, both AMF and UDM act as "NF Producer", where UDM producer refers Specification TS29.503 and AMF producer refers Specification TS29.518.

Besides emulating UDM and AMF, it also supports error tracking, regression testing, load testing. It can run pre-defined test scenarios against 5G interface test objects in a controlled and deterministic manner. Easy to use script syntax allows user to create conformance test cases based on their test plan.

MAPS™ 5G N8 Interface Emulator supports powerful utilities such as Script Editor and Profile Editor which allow new scenarios to be created or existing scenarios to be modified using 5G N8's JSON messages and parameters.

For more information, refer to [MAPS™ 5G N8 Interface Emulator](#) webpage.

Main Features

- Emulates Access and Mobility Management Function and Unified Data Management elements
- The following are the supported Services:
 - Nudm_UEContextManagement
 - Nudm_SubscriberDataManagement
- Services use REST APIs based on HTTP and JSON data format
- Supports TLS and TCP transports
- Supports scripted call generation and automated call reception
- Supports customization of call flow and message templates using Script Editor and JSON Messages
- Ready-to-use scripts for quick testing
- Provides Call Statistics and Events Status
- Emulates Multiple Subscribers using CSV Profiles
- Automation, Remote access, and Schedulers to run tests 24/7



818 West Diamond Avenue - Third Floor, Gaithersburg, MD 20878, U.S.A
(Web) www.gl.com - (V) +1-301-670-4784 (F) +1-301-670-9187 - (E-Mail) info@gl.com

Testbed Configuration

The testbed setup window allows users to setup the required test configurations in N8 interface. It includes a list of variables that are declared and assigned before starting the script. Testbed Setup defines the MAPS™ parameters which communicates with the rest of the test network. End user configuration profile is used to configure MAPS™ 5G N8 interface with the supported AMF and UDM parameters.

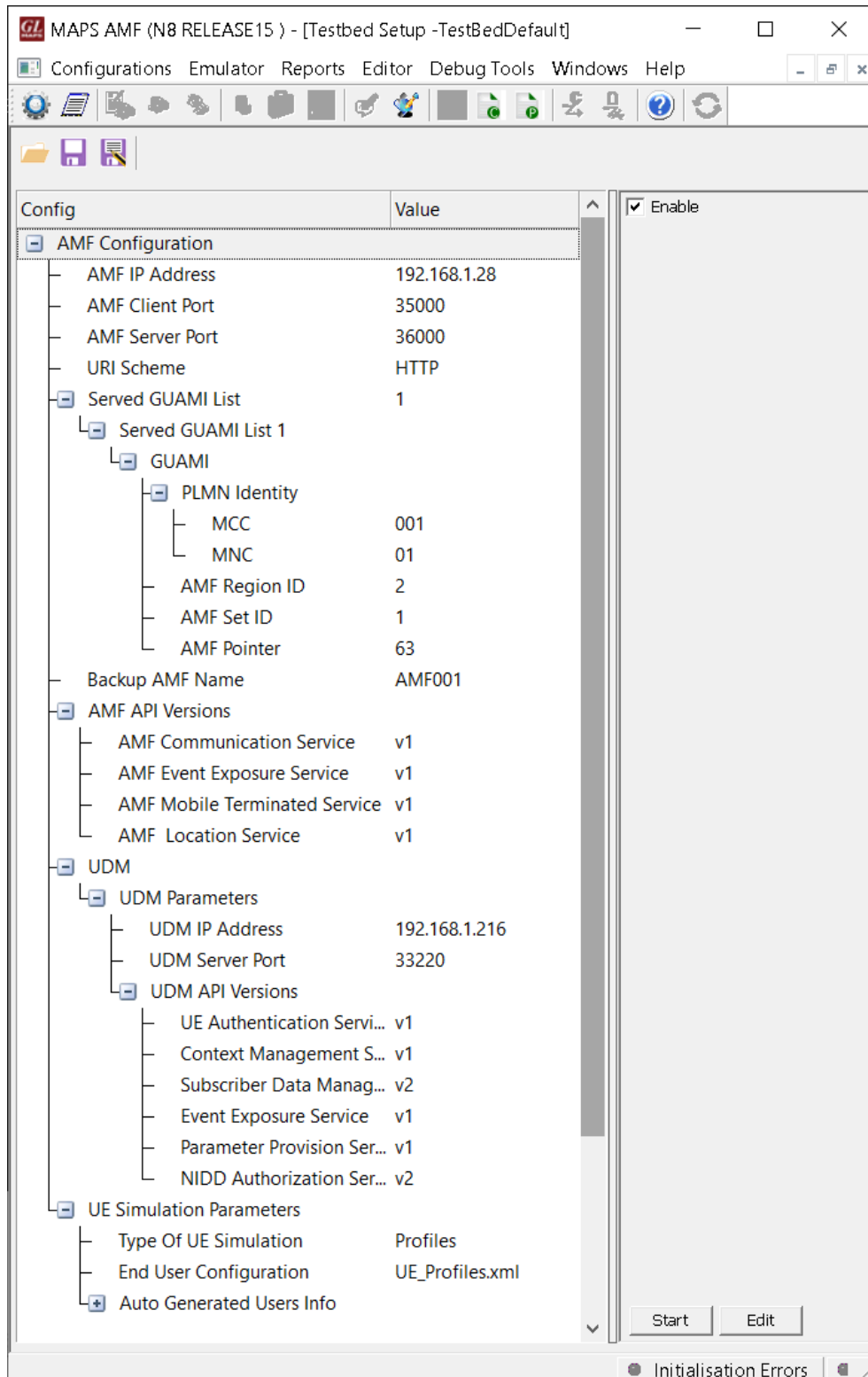

Figure: Testbed Setup

Pre-processing Tools

SCRIPT EDITOR - The script editor allows user to create/edit scripts and access protocol fields as variables for the message template parameters. The script uses pre-defined message templates, to perform send and receive actions.

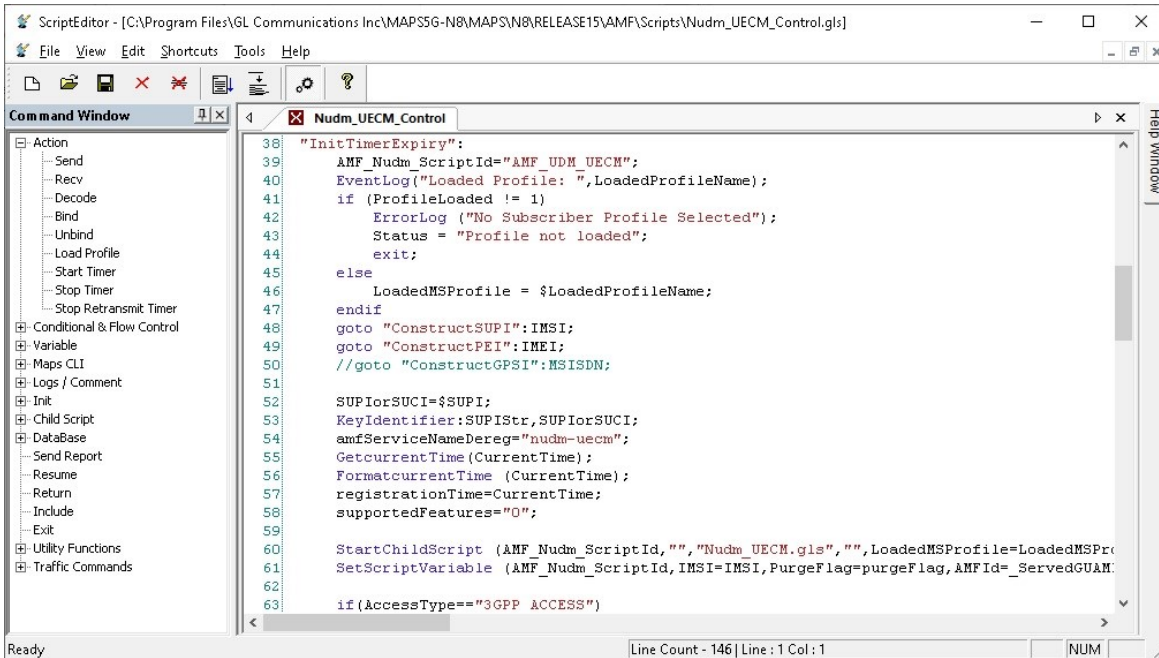

Figure: Script Editor

PROFILE EDITOR - This feature allows loading profile to edit the values of variables using GUI, replacing the original value of variables in the message template. An XML file defines a set of multiple profiles with varying parameter values which allows users to configure call instances in call generation to receive calls. The UE_Profiles includes 5G parameters, that is required to configure multiple UEs to emulate Signaling and Traffic.

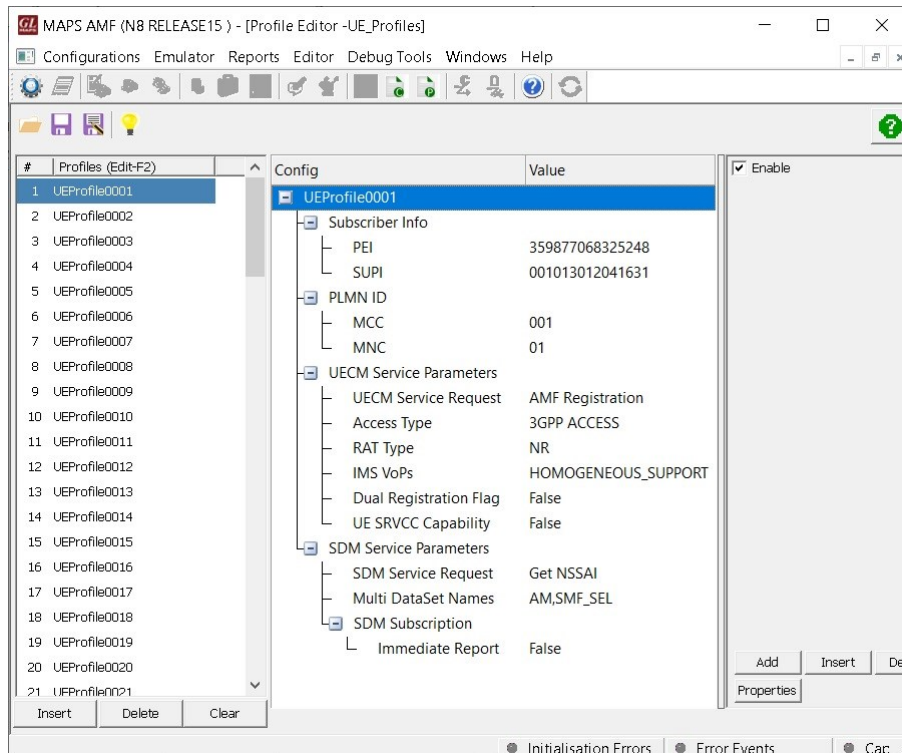

Figure: Profile Editor

Call Generation and Reception

In call generation mode, MAPS™ is configured for the outgoing messages, while in call receive mode, it is configured to respond to the incoming messages. Tests can be configured to run once, multiple iterations and continuously. Also, allows users to create multiple entries using quick configuration feature.

The editor allows to run the added scripts sequentially (order in which the scripts are added in the window) or randomly (any script from the list of added script as per the call flow requirements).

The test scripts are started manually at call generation, and at the call reception, the script is automatically triggered by incoming messages.

The screenshot shows the MAPS AMF (N8 RELEASE15) - [Call Generation -Default] interface. The top menu includes Configurations, Emulator, Reports, Editor, Debug Tools, Windows, and Help. Below the menu is a toolbar with various icons. A table displays the script execution results:

Sr No.	Script Name	Profile	Call Info	Script Execution	Status	Events	Result	Total Iterations	Completed Iterations
1	Nudm_UECM_Control.gls	UEProfile0001	SUPI:imsi-00...	Start	AMF Registration is successful	None	Pass	1	1
2	Nudm_SDM_Control.gls	UEProfile0001	SUPI:imsi-00...	Start	default Single NSSAI's Received	None	Pass	1	1
3	Nudm_UECM_Control.gls	UEProfile0002		Start		None	Unknown	1	0

Below the table is a toolbar with buttons: Add, Delete, Insert, Refresh, Start, Start All, Stop, Stop All, Abort, Abort All. The main area shows a message sequence diagram between AMF and UDM. The AMF sends a PUT request to the UDM: `PUT /nudm-uecm/v1/imsi-001013012041631/registrations/amf-3gpp-access` at 3:21:01.392000. The UDM responds with a 200 OK at 3:21:01.414000. To the right, the received JSON response is displayed:

```

PUT http://192.168.1.20:33220/nudm-uecm/v1/imsi-001013012041631/r
content-type : application/json
accept : application/json,
application/problem+json

{
  "amfInstanceId": "ea57b649-1985-4106-a129-78ef79a12289",
  "deregCallbackUri": "http://192.168.1.20:36000/nudm-uecm/v1/imsi-0
  "guami": {
    "amfId": "2163",
    "plmnId": {
      "mcc": "001",
      "mnc": "01"
    }
  },
  "imsVoPs": "HOMOGENEOUS_SUPPORT",
}

```

At the bottom, there are tabs for Scripts, Message Sequence, Event Config, and Script Flow. A status bar at the very bottom shows: Initialisation Errors, Error Events, Captured Errors, and Link Status U.

Figure: Call Generation

The screenshot shows the MAPS UDM (N8 RELEASE15) - [Call Reception] interface. The top menu includes Configurations, Emulator, Reports, Editor, Debug Tools, Windows, and Help. Below the menu is a toolbar with various icons. A table displays the script execution results:

Sr No	Script Name	Profile	Call Info	Script Execution	Status	Events	Events Pr...	Results
1	Nudm_UECM_Control.gls		SUPI:imsi-001013012041631	Completed	AMF Registration is updated	None		Pass
2	Nudm_SDM_Control.gls		SUPI:imsi-001013012041631	Completed	Successful Response Sent	None		Pass

Below the table is a toolbar with buttons: Stop, Stop All, Abort, Abort All, Show Records, Select Active Cal, Auto Trash, Trash. The main area shows a message sequence diagram between AMF and UDM. The AMF sends a PUT request to the UDM: `PUT /nudm-uecm/v1/imsi-001013012041631/registrations/amf-3gpp-access` at 3:10:21.398000. The UDM responds with a 200 at 3:10:21.401000. To the right, the received JSON response is displayed:

```

Status: 3
method : PUT
path : /nudm-uecm/v1/imsi-001013012041631/registrations,
scheme : http
authority : 192.168.1.20:33220
content-type : application/json
accept : application/json,
application/problem+json
content-length : 317

{
  "amfInstanceId": "ea57b649-1985-4106-a129-78ef79a12289",
  "deregCallbackUri": "http://192.168.1.20:36000/nudm-uecm/v
  "guami": {
    "amfId": "2163",
}

```

At the bottom, there are tabs for Scripts, Message Sequence, Event Config, and Script Flow. A status bar at the very bottom shows: Initialisation Errors, Error Events, Captured Errors, and Link Status U.

Figure: Call Reception

Nudm_UEContextManagement Service

AMF Registration for 3GPP Access

MAPS™ for N8 interface emulates services between AMF and UDM network functions. MAPS™ supports AMF registration for 3GPP access service.

In this procedure, the AMF sends a request to UDM to update the AMF registration information for 3GPP access. The request contains the UE's identity ($\{\text{ueid}\}$) which shall be a SUPI and the AMF Registration Information for 3GPP access.

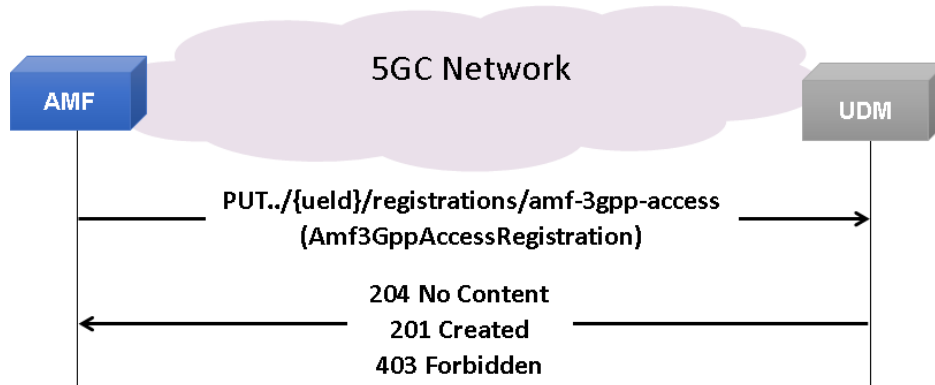

- AMF sends a PUT request to the UDM representing the UE's AMF registration for 3GPP access to update or create AMF registration information.
- On success, "204 No Content" is returned
- If the resource does not exist, UDM stores the received AMF registration data for 3GPP access and responds with HTTP Status Code "201 created".
- If the operation cannot be authorized due to e.g., UE does not have required subscription data, access barring or roaming restrictions, HTTP status code "403 Forbidden" should be returned.

Update AMF Registration for 3GPP access

MAPS™ for N8 interface emulates services between AMF and UDM network functions. MAPS™ supports Update AMF Registration for 3GPP access service.

The AMF sends a request to the UDM to update a parameter within the Amf3GppAccessRegistration resource. The request contains the UE's identity ($\{\text{ueid}\}$) which shall be a SUPI and an instruction to modify a parameter (e.g., PEI).

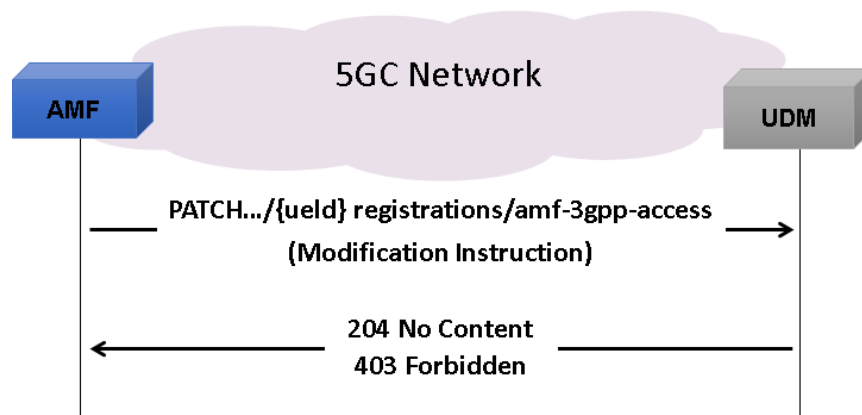

- The AMF sends a PATCH request to the resource representing the UE's AMF registration for 3GPP access.
- On success, the UDM responds with "204 No Content".
- On failure, an appropriate HTTP status code indicating the error shall be returned and appropriate additional error information should be returned in the PATCH response body.

Nudm_UEContextManagement Service (Contd.)

AMF Deregistration for 3GPP Access

MAPS™ for 5G N8 interface emulates services between UDM and AMF network functions.

The AMF sends a request to the UDM to deregister (purge) from the UDM for 3GPP access. The request contains the UE's identity (/ {ueld}) which shall be a SUPI and an instruction to set the purgeFlag within the Amf3GppAccessRegistration resource.

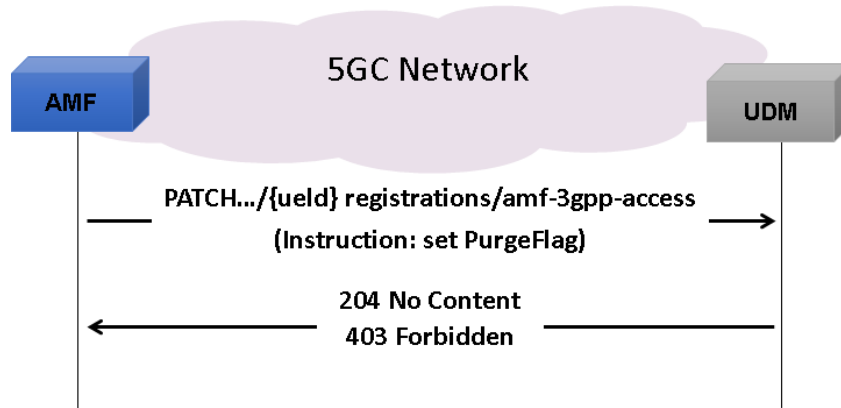

- The AMF sends a PATCH request to the resource representing the UE's AMF registration for 3GPP access.
- The UDM shall check whether the received GUAMI matches the stored GUAMI. If so, the UDM shall set the PurgeFlag. The UDM responds with "204 No Content".
- Otherwise, the UDM responds with "403 Forbidden".
- On failure, the appropriate HTTP status code indicating the error shall be returned and appropriate additional error information should be returned in the PATCH response body.

UDM Initiated NF Deregistration

MAPS™ for N8 interface emulates services between UDM and AMF network functions.

The UDM notifies the registered NF about its deregistration. The request contains the callback URI for deregistration notification as received by the UDM during registration, and Deregistration Data.

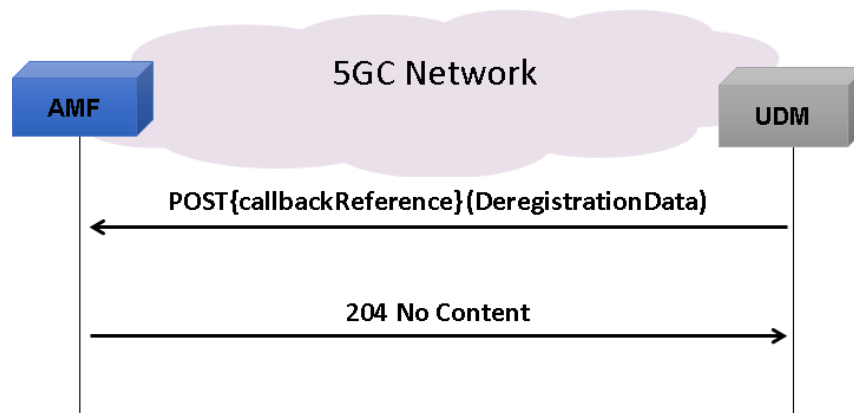

- The UDM sends a POST request to the callbackReference as provided by the NF service consumer during the registration.
- The NF service consumer responds with "204 No Content".
- On failure, the appropriate HTTP status code indicating the error shall be returned and appropriate additional error information should be returned in the POST response body.

Nudm_UEContextManagement Service (Contd.)

AMF Registration for Non 3GPP Access

MAPS™ for 5G N8 interface emulates services between UDM and AMF network functions.

AMF sends a request to the UDM to update the AMF registration information for non 3GPP access. The request contains the UE's identity ($\{/ueid\}$) which shall be a SUPI and the AMF Registration Information for non 3GPP access.

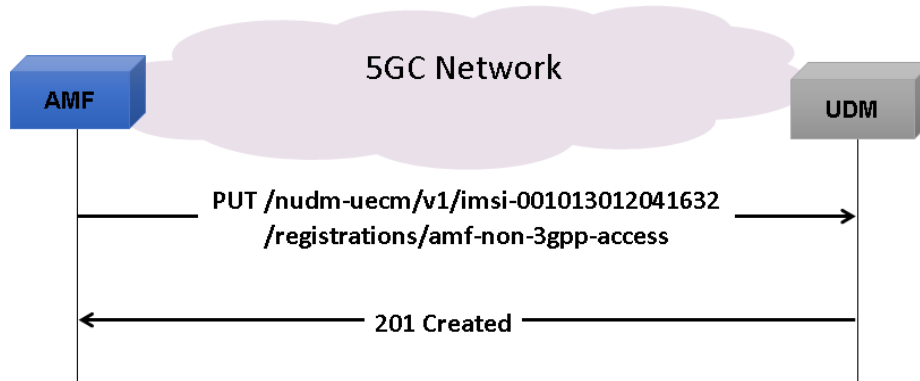

- The AMF sends a PUT request to the resource representing the UE's AMF registration for non 3GPP access to update or create AMF registration information.
- On success, the UDM updates the AMF Non 3Gpp Access Registration resource by replacing it with the received resource information and responds with "200 OK" or "204 No Content".
- On failure, the appropriate HTTP status code indicating the error shall be returned and appropriate additional error information should be returned in the PUT response body.

Update AMF Registration for Non 3GPP Access

The AMF sends a request to the UDM to update a parameter within the AmfNon3GppAccessRegistration resource. The request contains the UE's identity ($\{/nudm-uecm\}$) which shall be a IMSI and an instruction to modify a parameter (e.g. PEI).

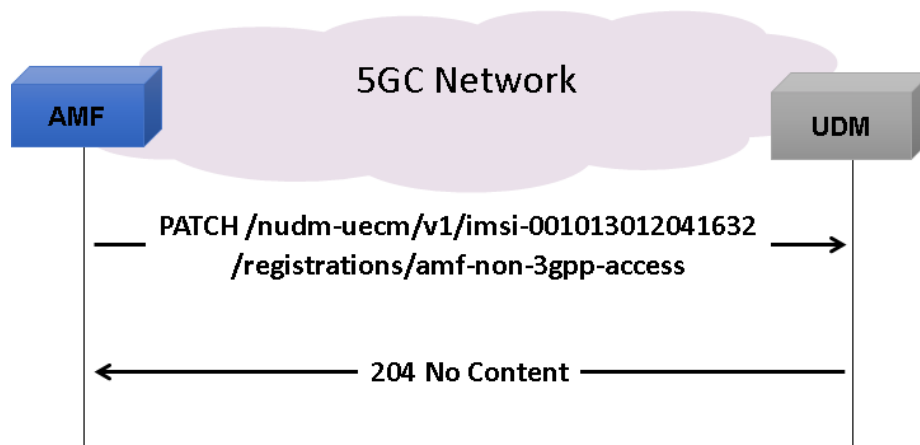

- The AMF sends a PATCH request to the resource representing the UE's AMF registration for non-3GPP access.
- On success, the UDM responds with "204 No Content".
- On failure, the appropriate HTTP status code indicating the error shall be returned and appropriate additional error information should be returned in the PATCH response body.

Nudm_UEContextManagement Service (Contd.)

AMF De-registration for Non 3GPP Access

The AMF sends a request to the UDM to deregister (purge) from the UDM for non-3GPP access. The request contains the UE's identity which shall be a IMSI and an instruction to set the purgeFlag within the AmfNon3GppAccessRegistration resource.

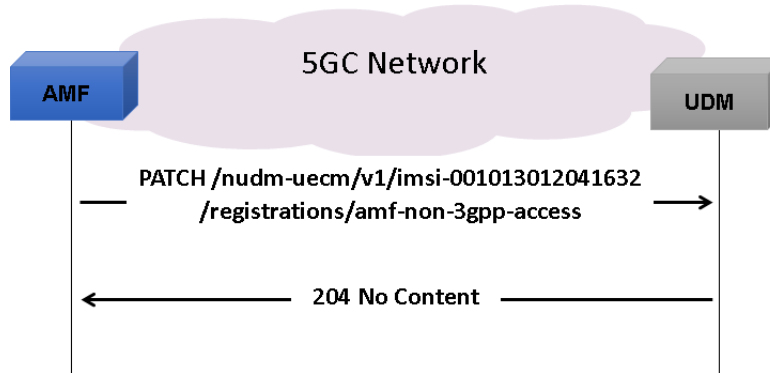

- The AMF sends a PATCH request to the resource representing the UE's AMF registration for non-3GPP access.
- The UDM shall check whether the received GUAMI matches the stored GUAMI. If it matches, the UDM shall set the PurgeFlag and responds with "204 No Content".
- Otherwise the UDM responds with "403 Forbidden".
- On failure, the appropriate HTTP status code indicating the error shall be returned and appropriate additional error information should be returned in the PATCH response body.

Nudm_SubscriberDataManagement Service

Slice Selection Subscription Data Retrieval

The NF service consumer (e.g. AMF) sends a request to the UDM to receive the UE's NSSAI. The request contains the UE's identity (/ {supi}), the type of the requested information (/nssai) and query parameters (supported-features, plmn-id).

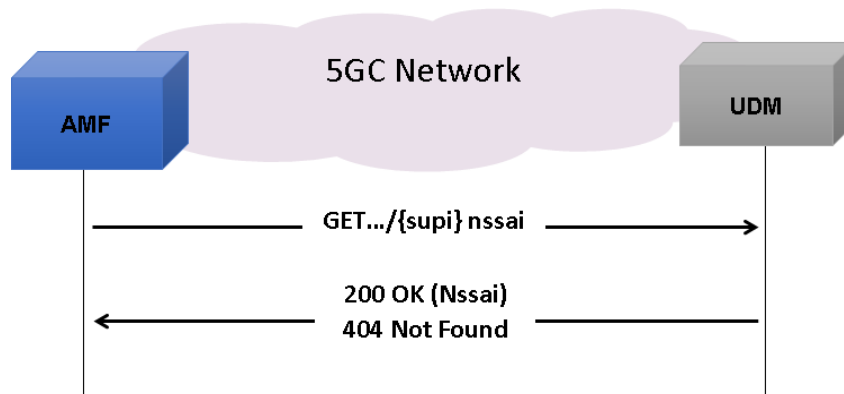

- The NF service consumer (e.g. AMF) sends a GET request to the resource representing the UE's subscribed NSSAI, with query parameters.
- On success, the UDM responds with "200 OK"
- If there is no valid subscription data for the UE, HTTP status code "404 Not Found" shall be returned.
- On failure, the appropriate HTTP status code indicating the error shall be returned.

Nudm_SubscriberDataManagement Service (Contd.)

Access and Mobility Subscription Data Retrieval

The NF service consumer (e.g. AMF) sends a request to the UDM to receive the UE's Access and Mobility Subscription data. The request contains the UE's identity ($\{/supi\}$), the type of the requested information ($\{/am-data\}$) and query parameters (supported-features, plmn-id).

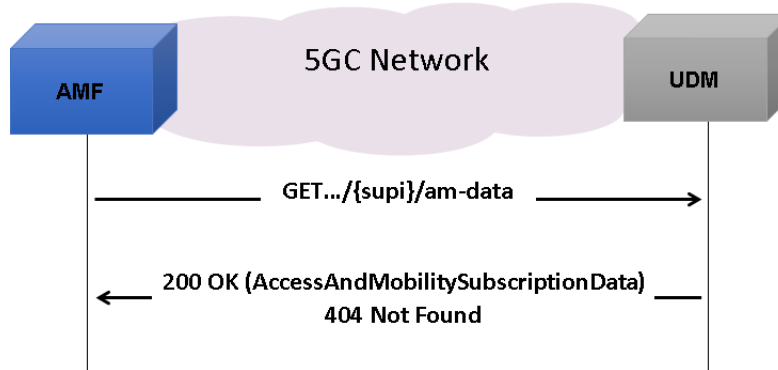

- The NF service consumer (e.g. AMF) sends a GET request to the resource representing the UE's Access and Mobility Subscription Data, with query parameters indicating the supported-features and/or plmn-id.
- On Success, the UDM responds with "200 OK".
- If there is no valid subscription data for the UE, HTTP status code "404 Not Found" shall be returned.
- On failure, the appropriate HTTP status code indicating the error shall be returned.

SMF Selection Subscription Data Retrieval

The NF service consumer (e.g. AMF) sends a request to the UDM to receive the UE's SMF Selection Subscription data. The request contains the UE's identity ($\{/supi\}$), the type of the requested information ($\{/smf-select-data\}$) and query parameters (supported features, plmn-id).

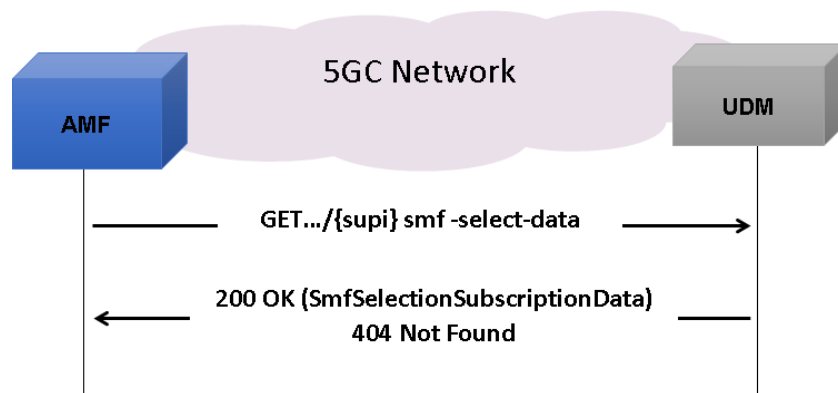

- The NF service consumer (e.g. AMF) sends a GET request to the resource representing the UE's SMF Selection Subscription Data, with query parameters.
- On success, the UDM responds with "200 OK".
- If there is no valid subscription data for the UE, HTTP status code "404 Not Found" shall be returned.
- On failure, the appropriate HTTP status code indicating the error shall be returned.

Nudm_SubscriberDataManagement Service (Contd.)

SMS Subscription Data Retrieval

The NF service consumer (e.g. AMF) sends a request to the UDM to receive the UE's SMS Subscription Data. The request contains the UE's identity (`/supi`) and the type of the requested information (`/sms-data`).

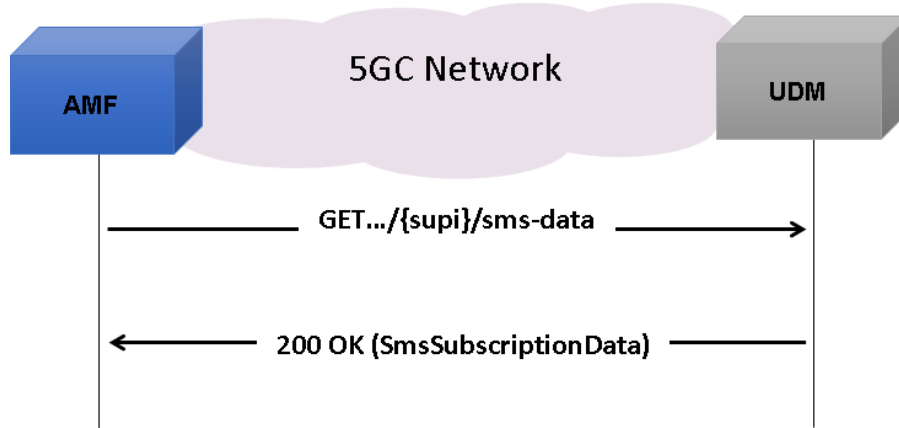

- The NF Service Consumer (e.g. AMF) sends a GET request to the resource representing the UE's SMS Subscription Data.
- The UDM responds with "200 OK".
- On failure, the appropriate HTTP status code indicating the error shall be returned and appropriate additional error information should be returned in the GET response body.

UE Context in SMF Data Retrieval

The NF service consumer (e.g. AMF) sends a request to the UDM to receive the UE's Context In SMF data. The request contains the UE's identity (`/supi`), the type of the requested information (`/ue-context-in-smf-data`) and query parameters.

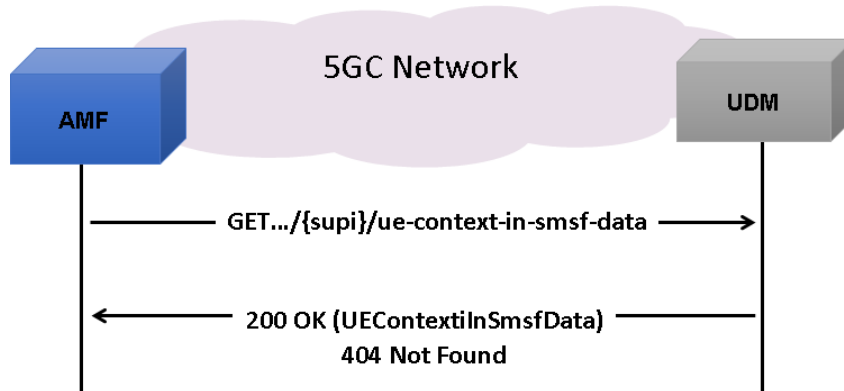

- The NF service consumer (e.g. AMF) shall send a GET request to the resource representing the UE's Context In SMF Data, with query parameters indicating the supported-features.
- On Success, the UDM shall respond with "200 OK" with the message body containing the UE's Context In SMF Data as relevant for the requesting NF service consumer.
- On failure, the appropriate HTTP status code indicating the error shall be returned and appropriate additional error information should be returned in the GET response body.

Nudm_SubscriberDataManagement Service (Contd.)

Retrieval Of Multiple Data Sets

The NF service consumer (e.g., AMF) sends a request to the UDM to receive multiple data sets. In this example scenario the UE's Access and Mobility Subscription data and the UE's SMF Selection Subscription data are retrieved with a single request.

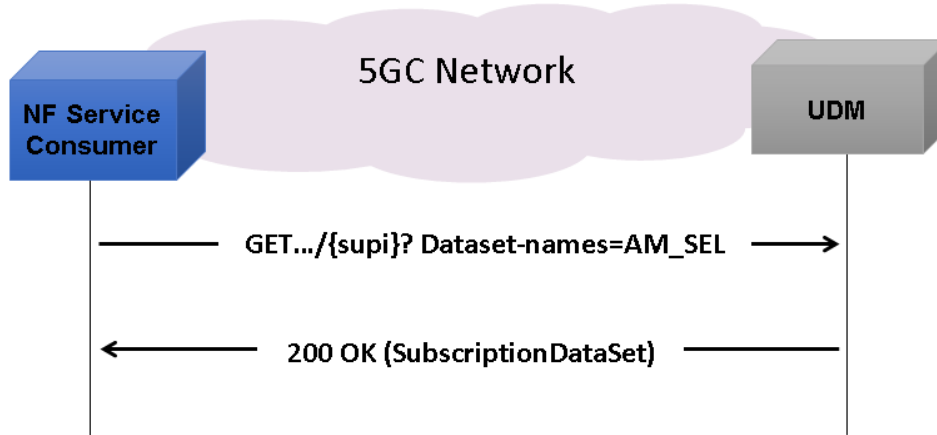

- The NF Service Consumer (e.g., AMF) sends a GET request to the resource representing the supi. Query parameters indicate the requested data sets.
- The UDM responds with "200 OK" with the message body containing the requested data sets.
- On failure, the appropriate HTTP status code indicating the error shall be returned and appropriate additional error information should be returned in the GET response body.

UE Context in SMSF Data Retrieval

The NF service consumer (e.g., AMF) sends a request to the UDM to receive the UE's Context In SMSF data. The request contains the UE's identity (`{supi}`), the type of requested information (`/ue-context-in-smsf-data`) and query parameters.

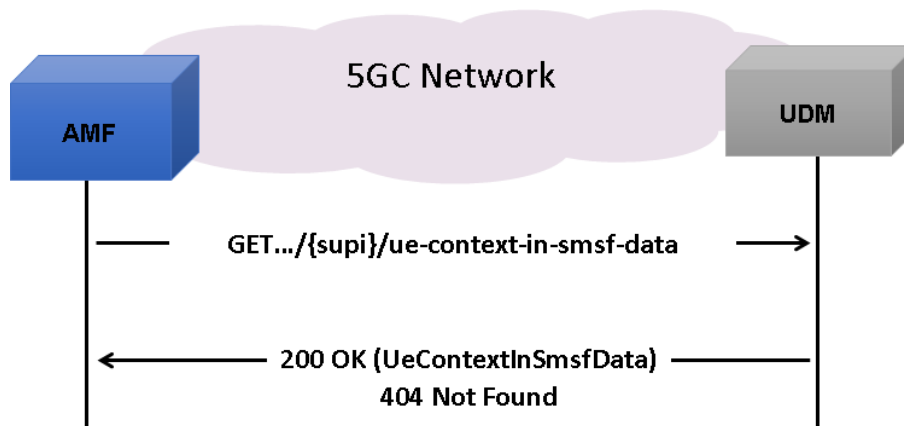

- The NF service consumer (e.g., AMF) shall send a GET request to the resource representing the UE's Context In SMSF Data, with query parameters indicating the supported-features.
- On Success, the UDM shall respond with "200 OK" with the message body containing the UE's Context In SMSF Data as relevant for the requesting NF service consumer.
- On failure, the appropriate HTTP status code indicating the error shall be returned and appropriate additional error information should be returned in the GET response body.

Nudm_SubscriberDataManagement Service (Contd.)

LCS Mobile Originated Data Retrieval

The NF service consumer (e.g., AMF) sends a request to the UDM to receive the UE's LCS Mobile Originated Subscription data. The request contains the UE's identity ($\{/supi\}$), the type of the requested information ($\{/lcs-mo-data\}$) and query parameters.

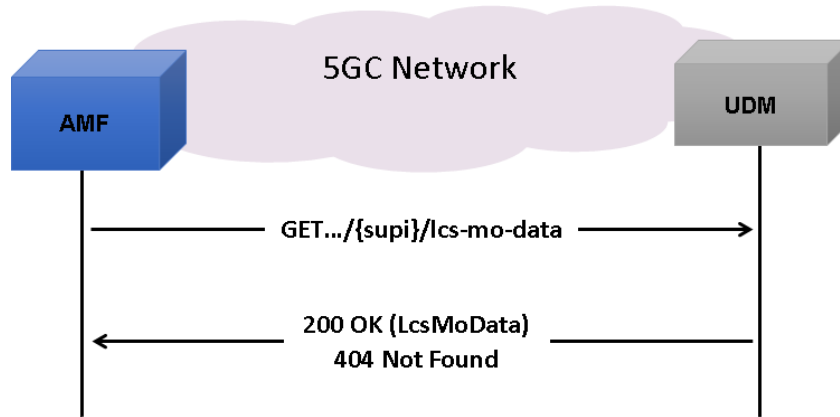

- The NF service consumer (e.g. AMF) sends a GET request to the resource representing the UE's LCS Mobile Originated Subscription Data, with query parameters indicating the supported-features.
- On Success, the UDM responds with "200 OK" with the message body containing the UE's LCS Mobile Originated Subscription Data as relevant for the requesting NF service consumer.
- On failure, the appropriate HTTP status code indicating the error shall be returned and appropriate additional error information should be returned in the GET response body.

Subscription to Notifications of Data Change

The NF service consumer sends a request to the UDM to subscribe to notifications of data change. The request contains a call back URI and the URI of the monitored resource.

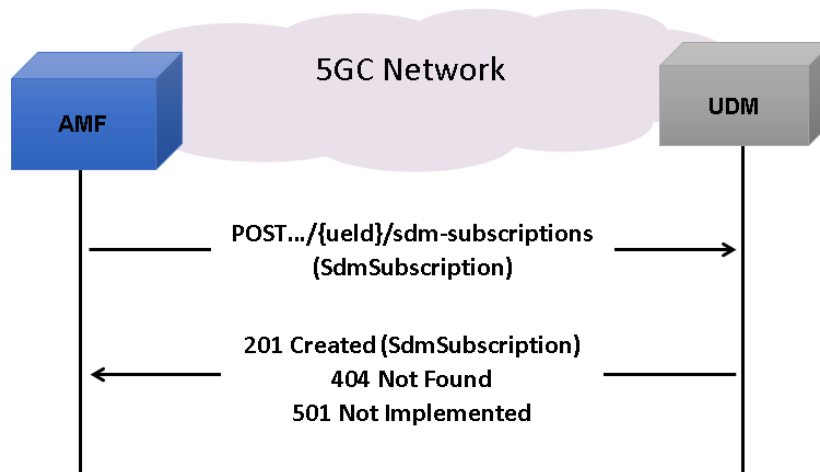

- The NF service consumer sends a POST request to the parent resource, to create a subscription as present in message body. The payload body of the POST request shall contain a representation of the individual subscription resource to be created. There shall be only one subscription per UE per NF service consumer identified by the ueld in URI and NfInstanceId in SdmSubscription.
- On success, the UDM responds with "201 Created" with the message body containing a representation of the created subscription. The Location HTTP header shall contain the URI of the created subscription.
- On failure, the appropriate HTTP status code indicating the error shall be returned and appropriate additional error information should be returned in the POST response body.

Nudm_SubscriberDataManagement Service (Contd.)

Modification of a subscription to notifications of data change

The NF service consumer sends a request to the UDM to modify a subscription to notifications of data changes. The request contains the URI previously received in the Location HTTP header of the response to the subscription.

- The NF service consumer sends a PATCH request to the resource identified by the URI previously received during subscription creation.
- On success, the UDM responds with "200 OK".
- On failure, the appropriate HTTP status code indicating the error shall be returned and appropriate additional error information should be returned in the PATCH response body.

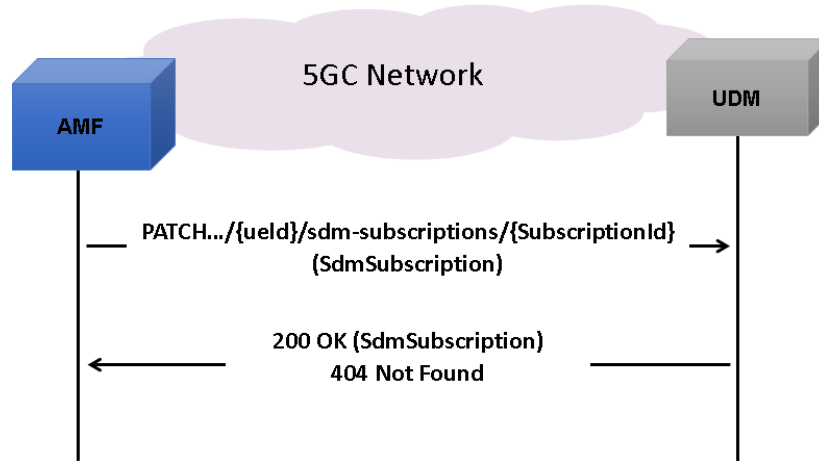

Unsubscribe to notifications of data change

The NF service consumer sends a request to the UDM to unsubscribe from notifications of data changes. The request contains the URI previously received in the Location HTTP header of the response to the subscription.

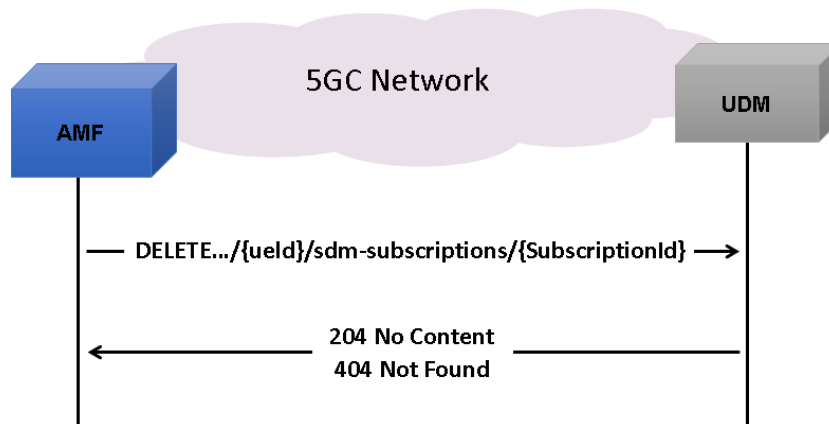

- The NF service consumer sends a DELETE request to the resource identified by the URI previously received during subscription creation.
- On success, the UDM responds with "204 No Content".
- On failure, the appropriate HTTP status code indicating the error shall be returned and appropriate additional error information should be returned in the DELETE response body.

Supported Protocols and Specifications

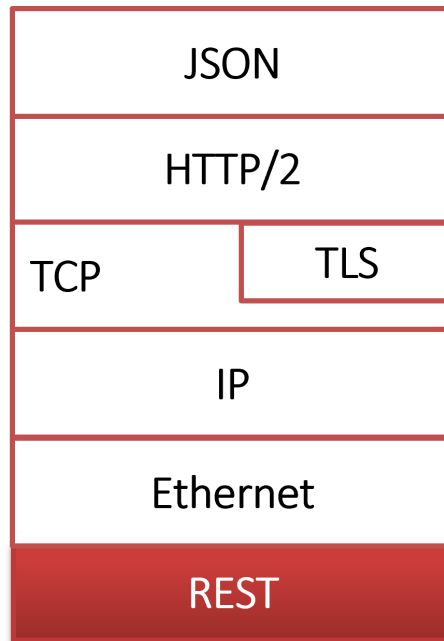

Supported Protocol	Standard/ Specification
N8 Interface (UDM - AMF)	TS29.503 Release 15
JavaScript Object Notation (JSON)	IETF RFC 8259
HTTP/2	IETF RFC 7231 IETF RFC 7540/RFC 7541
TLS	IETF RFC 8446
TCP	IETF RFC 793
IPv4	IETF RFC 791 [5] IETF RFC 2460 [6]

Buyer's Guide

Item No	Product Description
PKS503	MAPS™ 5G N8 Interface Emulator (Requires PKS502)
PKS305	MAPS™ 5G Multi-Interface Emulation

Item No	Related Software
PKS500	MAPS™ 5G N1/N2 Interface Emulator
PKS501	MAPS™ 5G N4 Interface Emulator
PKS502	5G service-based Emulation (Prerequisite base license for all service-based (Open API) interface emulations)
PKS502	MAPS™ 5G N17 Interface Emulator
PKS504	MAPS™ 5G N10 Interface Emulator (Requires PKS502)
PKS505	MAPS™ 5G N11 Interface Emulator (Requires PKS502)
PKS506	MAPS™ 5G N12 Interface Emulator (Requires PKS502)
PKS507	MAPS™ 5G N13 Interface Emulator (Requires PKS502)
PKS508	MAPS™ 5G N20 Interface Emulator (Requires PKS502)
PKS509	MAPS™ 5G N21 Interface Emulator (Requires PKS502)
PKS510	MAPS™ 5G N22 Interface Emulator (Requires PKS502)
PKS511	MAPS™ 5G N29 Interface Emulator (Requires PKS502)
PKS511	MAPS™ 5G N51 Interface Emulator (Requires PKS502)

For complete list of MAPS™ products, refer to [Message Automation & Protocol Simulation \(MAPS™\)](#) webpage.

For more details on supported MAPS™ 5G interfaces, refer to [5G Core \(5GC\) Network Test Solution](#) webpage.



GL Communications Inc.

818 West Diamond Avenue - Third Floor, Gaithersburg, MD 20878, U.S.A
 (Web) www.gl.com - (V) +1-301-670-4784 (F) +1-301-670-9187 - (E-Mail) info@gl.com