

MAPS™ Long Term Evolution (LTE) S1 Conformance

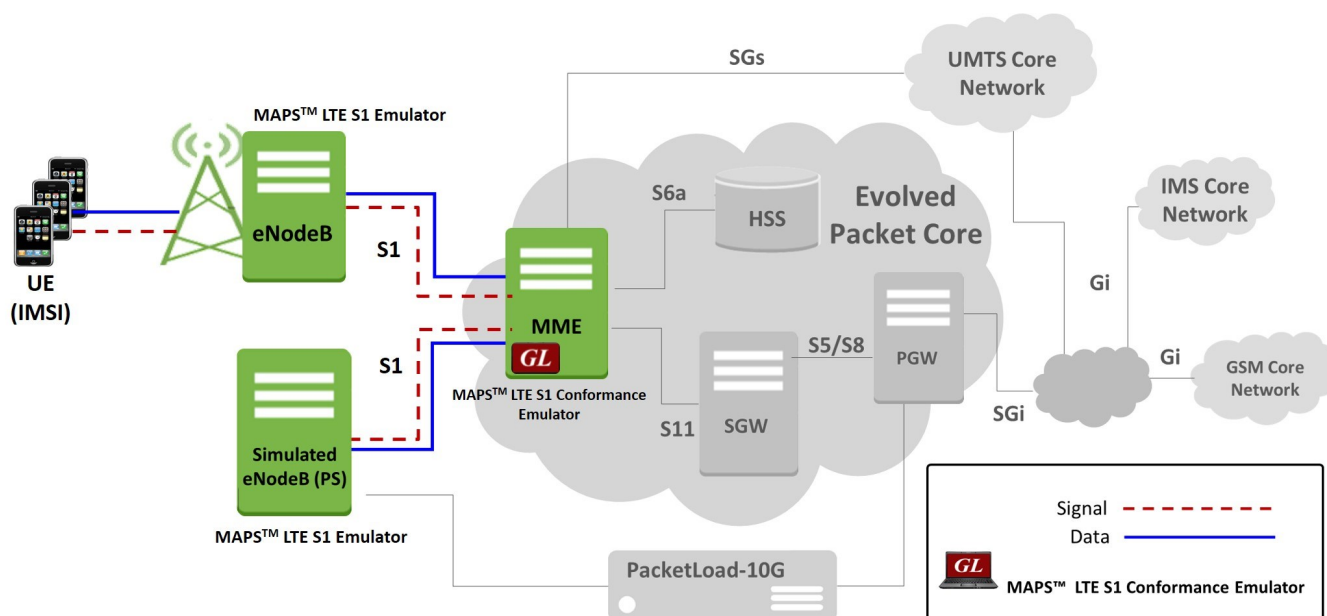

Overview

GL's MAPS™ S1 LTE Conformance Test Suite is designed with 50+ test cases, supporting various success/failure test cases, as per 3GPP TS 36.413 (LTE S1) specifications. It includes inbuilt conformance scripts (*.gls) for S1 interface conformance testing.

The above diagram depicts the internals of LTE Network and MAPS™ LTE S1 Conformance can be configured to act as MME node to test eNodeB acting as dut. to simulate different network side procedures conforming various success/failure test cases and automating the entire eNodeB (DUT) testing.

Test cases include general Evolved Universal Terrestrial Radio Access Network (E-UTRAN), S1 Application Protocol (S1AP) messaging and call flow scenarios over LTE network. Logging and pass/fail results are also reported. Test cases verify conformance of actions such as UE attach/detach, periodic updating, Handover procedure, UE context release, and error indication

For more information, please visit [MAPS™ LTE S1](#) webpage.

Main Features

- Supports LTE Control plane.
- Simulates MME Node
- Generates and process S1/NAS (valid and invalid) messages.
- Insertion of impairments to create invalid messages
- Supports customization of call flow and message templates using Script and Message Editor.
- Ready-to-use scripts for quick testing
- Supports scripted call generation and automated call reception.
- Provides Call Statistics and Events Status.
- Test suite can run pre-defined test scenarios against LTE interface test objects in a controlled and deterministic manner.



818 West Diamond Avenue - Third Floor, Gaithersburg, MD 20878, U.S.A
(Web) www.gl.com - (V) +1-301-670-4784 (F) +1-301-670-9187 - (E-Mail) info@gl.com

Testbed Configuration

The testbed setup window allows users to setup the required test environment with SCTP configuration in S1 interface.

SCTP Configuration parameters consists of source / destination IP address, port, to configure MAPS™ to simulate MME entities in S1 interface. MAPS™ can then generate and receive S1AP/NAS messages to/from valid IP Address in the LTE network.

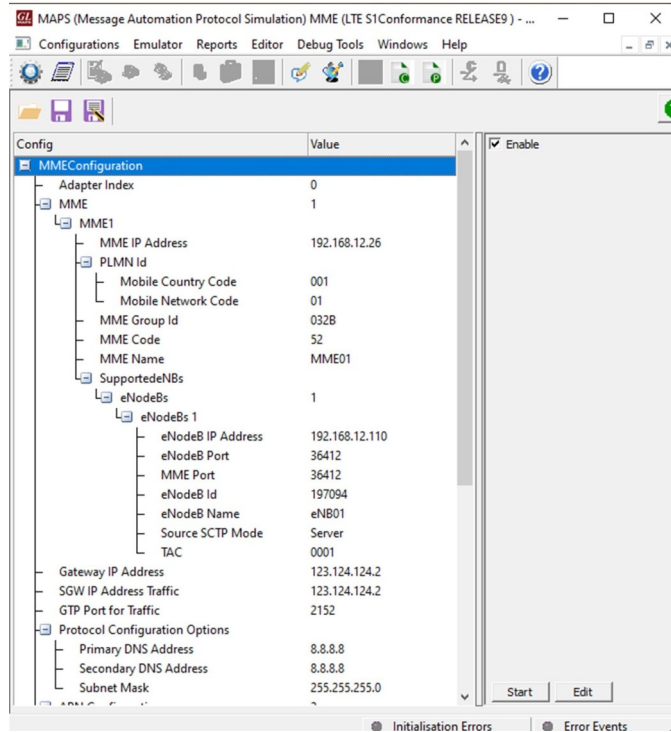

Figure: Testbed Setup

Pre-processing Tools

Message Editor

With message editor, users can build a template for each protocol message type. The value for each field may be changed in the message template prior to testing. The protocol fields comprises of mandatory fixed parameters, mandatory variable parameters, & optional variable parameters.

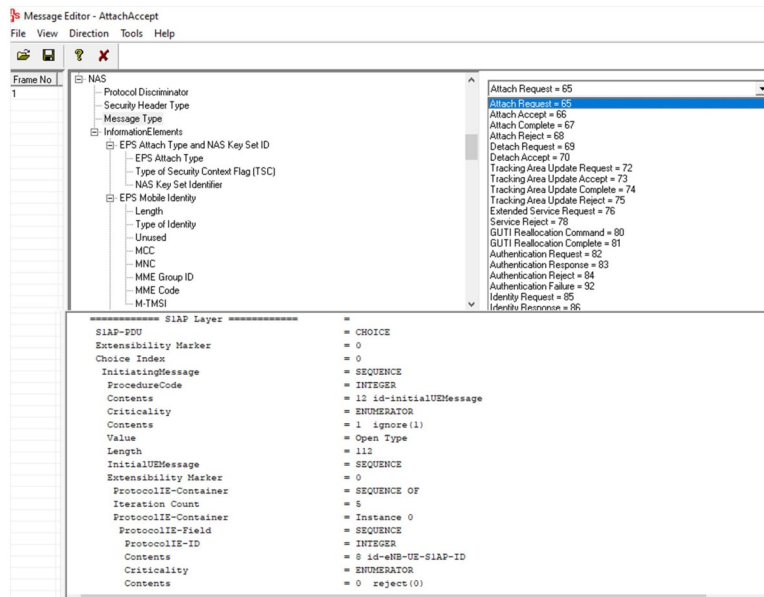

Figure: Message Editor

Pre-processing Tools (Contd.)

Script Editor

The script editor allows the user to create / edit scripts and access protocol fields as variables for the message template parameters. The script uses pre-defined message templates to perform send and receive actions.

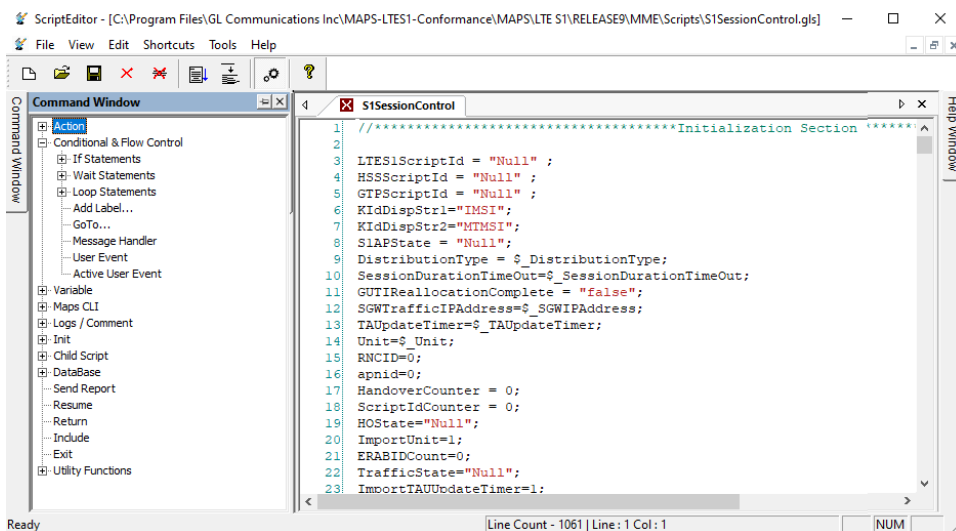

Figure: Script Editor

Profile Editor

This feature allows loading profile to edit the values of the variables using GUI, replacing the original value of the variables in the message template. An XML file defines a set of multiple profiles with varying parameter values that allow users to configure call instances in call generation and to receive calls. The UE_Profiles includes parameters required to perform conformance test on selected test case.

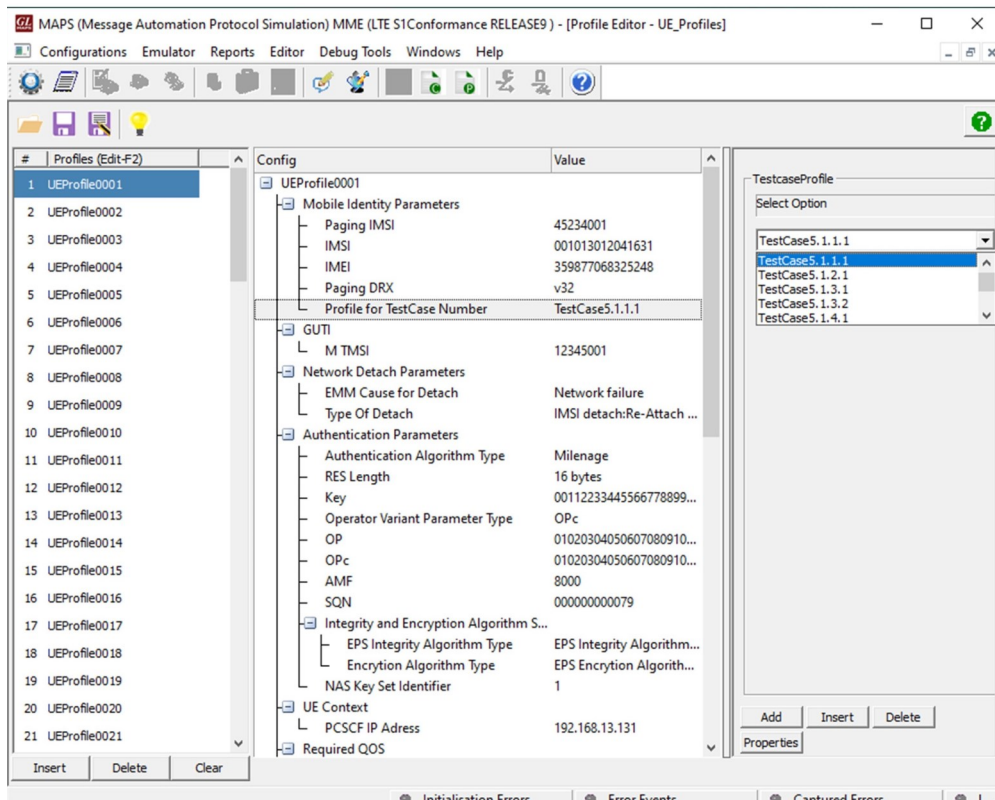

Figure: Profile Editor

UE Attach Success Conformance Testing

The attach procedure is used to attach an EPC for packet services in EPS. The UE initiates the attach procedure by sending an Attach Request message to the MME. Here, MAPS™ LTE S1 Conformance acts as MME performs the successful UE attach procedure after receiving INITIAL UE message from eNB.(MAPS LTE S1 Emulator configured to act as enodeB) If the UE is authenticated and security check is completed the network accepts the Attach Request from UE and sends the attach response. The below figure shows the conformance simulation.

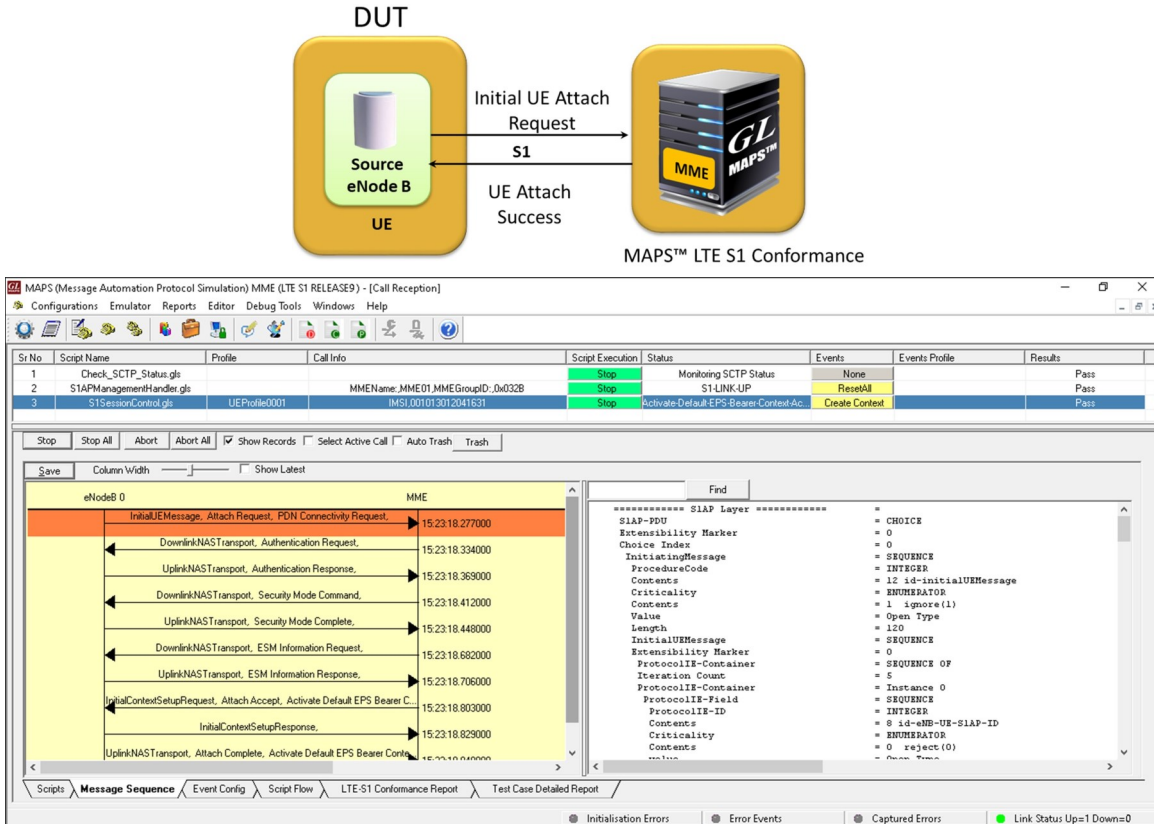

Figure: UE Attach Success S1 Conformance

Reports

The **LTE-S1 Conformance Report** tab in the Call Reception window, provides the Test case name, Test Case Number, Test Description, Date, Time and Test Result for the selected test case to verify the conformance result. The selected test case details can be verified by **Test Case Detailed Report** tab in Call reception window that provides details about test case like Test Case Name, Message, Message Direction, InformationElement and ExpectedValues

Figure: LTE S1 Conformance Report and Test Case Detailed Report

Supported Test Cases

- Paging success/failure
- Paging via IMSI success/failure
- UE attach success, UE detach, UE tracking area update
- Periodic updating
- Service Request
- E-RAB Setup procedures
 - GBR E-RAB setup success
 - Non GBR E-RAB setup success
 - E-RAB setup failure
 - E-RAB release
 - E-RAB Modify - priority trigger, QCI changes, UE AMBR
 - E-RAB Modify failure
- Setup context – Fail, Success
- UE Context Release, Modification
- Handover
 - Success Handover S1 interface
 - Handover prepare failure
 - Handover resource allocation failure
 - Handover failed: Multiple E-RAB ID instances
 - Handover Cancel
- S1 Setup
 - S1 Setup Success
 - setup failure and resend setup
- Reset all resource, partial resource
- Error Indication
- Location report

Supported Protocols and Specifications

Supported Protocols	Standard / Specification Used
S1 Application Protocol (S1-AP)	3GPP 36.413 9.0.0 (2009-09)
SCTP	RFC 4960
Non-Access-Stratum (NAS)	3GPP TS 24.301 V9.0.0 (2009-09)

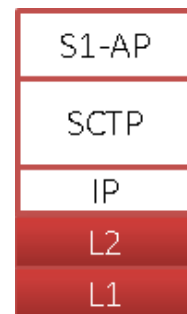

Buyer's Guide

Item No	Product Description
PKS154	LTE S1 Conformance Test Suite
PKS140	MAPS™ LTE S1 Interface Emulator
ETH101	MobileTrafficCore - GTP
ETH102	MobileTrafficCore - Gateway

For more information, please visit [Signaling and Traffic Simulator](#) webpage.



GL Communications Inc.

818 West Diamond Avenue - Third Floor, Gaithersburg, MD 20878, U.S.A

(Web) www.gl.com - (V) +1-301-670-4784 (F) +1-301-670-9187 - (E-Mail) info@gl.com